

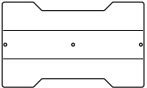
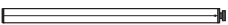

# rapido *twin*

notice de montage

option **bord droit**

- x1 
- x2 
- x2 
- (x2) 

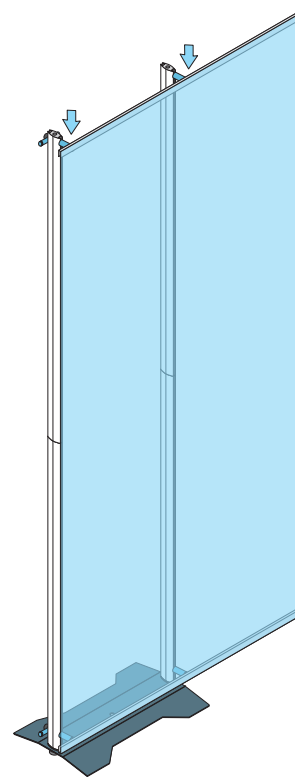
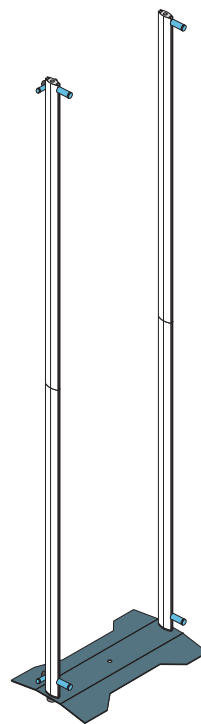
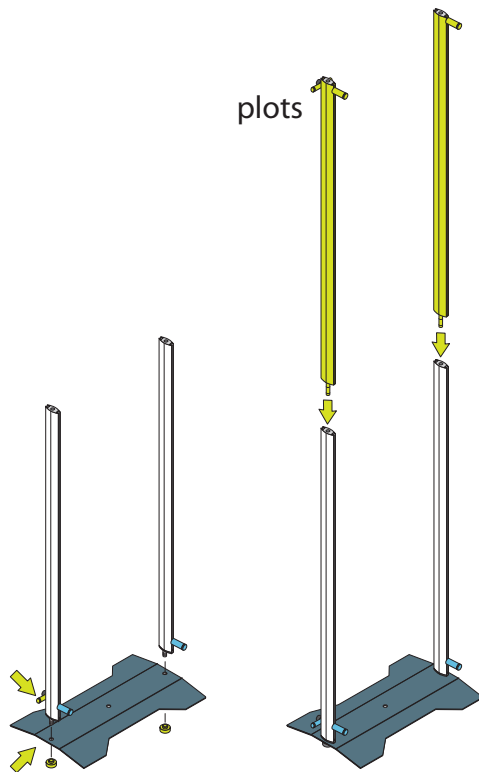

→ panneau droit :  
suspendre le haut,  
puis tendre avec  
les plots du bas.

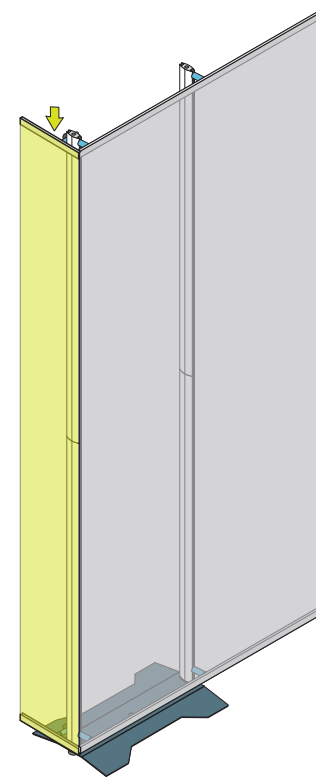

→ bord droit :  
suspendre le haut,  
puis tendre avec  
le plot du bas.